

**Segway® HT
riders' guide**

- > i Series
- > p Series
- > Segway XT
- > Segway GT

before you ride, study this guide.



how to ride the Segway Human Transporter (HT) safely.

the Segway HT riders' guide

The Segway HT is unlike anything you have ever experienced. To ride it safely you must read the Riders' Guide for your Segway HT model and watch the Safety Video. If you don't have the Safety Video, contact an Authorized Segway Dealer. For a list of Dealers, visit www.segway.com. **Use this guide for the following Segway HT models: i Series, p Series, Segway Cross-Terrain Transporter (XT), and Segway Golf Transporter (GT).** For other Segway HT models, contact Segway or an Authorized Segway Dealer to obtain user materials. Check the website for updates to Segway HT user materials: www.segway.com.



WARNING!

RISK OF DEATH OR SERIOUS INJURY

Whenever you ride the Segway HT, you risk death or serious injury from loss of control, collisions, and falls. To reduce risk of injury, you must read and follow all instructions and warnings in the Riders' Guide for your Segway HT model and you must watch the Safety Video.



Watch the Safety Video

This Riders' Guide is designed to be used in conjunction with the Safety Video. There is unique information in both the Riders' Guide and the Safety Video. Please use both!



Segway LLC Contact Information

Segway Customer Operations: 1-866-4SEGWAY (1-866-473-4929). Fax: 1-603-222-6001.
Email: technicalsupport@segway.com. Website: www.segway.com.

the risk of injury

The Segway HT is a self-balancing human transporter that uses patented balancing technology. Balancing technology cannot prevent injury if you do not ride the Segway HT safely. Whenever you ride the Segway HT, you risk injury from loss of control, collisions, and falls. It is your responsibility to learn how to safely ride the Segway HT in order to reduce this risk. This Riders' Guide and the Safety Video are designed to help you learn.

learning to ride the Segway HT

Segway wants you to be safe and enjoy learning how to ride your Segway HT.

Think about how you learned to ride a bike, drive a car, ski, or do just about anything else involving transportation. You probably had somebody help you learn. You started in a safe location. You started slowly. All these techniques apply to the Segway HT.

If you carefully follow all the instructions and warnings in this Riders' Guide and the Safety Video, you should be able to teach yourself how to ride the Segway HT, but you must be careful. If you try to teach yourself without reading this guide and watching the video, you are at much greater risk of injury. **Please don't take that risk.**

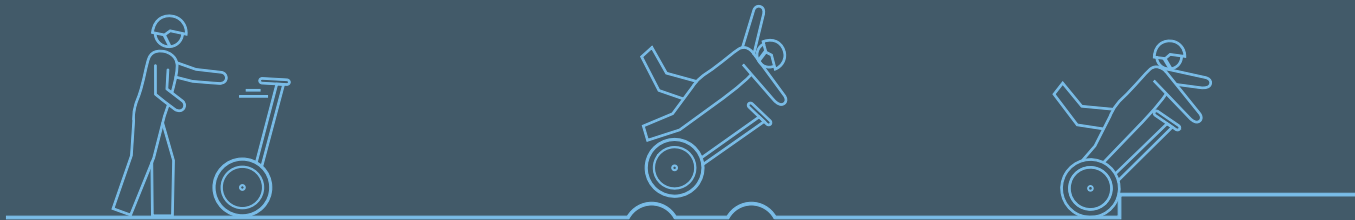

Segway HT models

This guide provides instructions on how to ride the i Series, p Series, Segway XT and Segway GT models. Please refer to the Reference Manual for model descriptions and specifications.

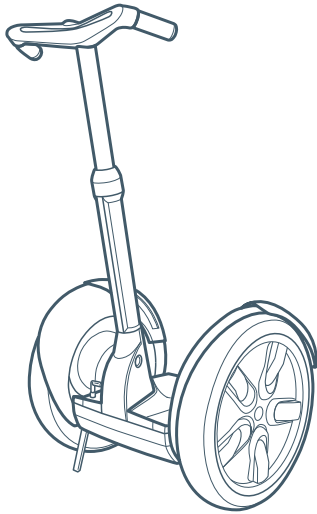

i Series

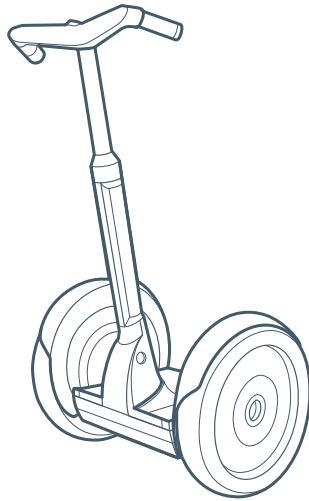

p Series

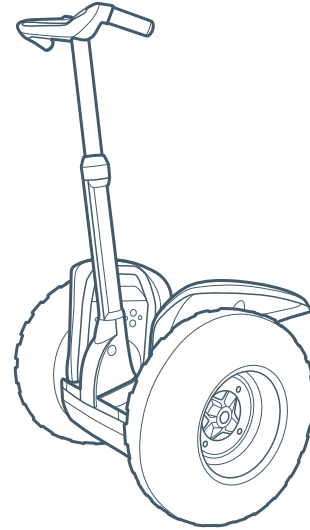

Segway XT

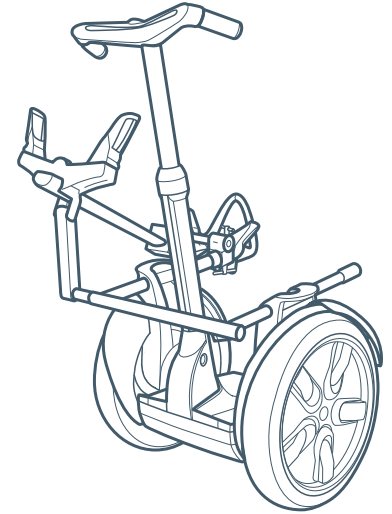

Segway GT

how the Segway HT balances... and how it can fall

The Segway HT's sensors detect whether the Segway HT and rider are leaning forward or backward. The Segway HT then immediately instructs its Wheels to roll forward or backward as necessary to stay upright. When you ride the Segway HT, you gently lean forward to make it go forward, you center your weight over the Wheels to remain stationary, and you gently lean backward to make it go backward. With practice, you will easily learn how to move forward and backward, turn and stop. Whenever riding, avoid abrupt maneuvers. Fast starts, fast stops, and fast turns are dangerous and can lead to loss of control, collisions, and falls.

Even with its balancing ability, the Segway HT, just like a person, can slip, trip, and tip over. To reduce risk of injury, you must avoid slips, trips, and tips.

As described in this guide and the Safety Video, all Segway HT riders should first learn to ride, and practice riding, in an area with a level, smooth riding surface with good traction, without obstructions. This applies to Segway XT and Segway GT riders, too. Even though both models have Tires that provide increased traction, the rider must still learn to ride as described in this guide and the Safety Video, and learn how to avoid slips, trips, and tips. All Segway HT riders should only gradually move onto more varied or rugged terrain as their riding skills improve with practice.

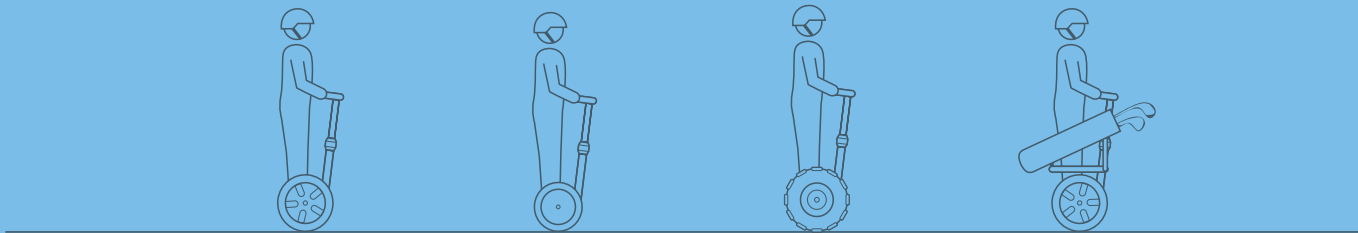

slips

Loss of traction leads to falls.

The Segway HT Tires must grip the ground for the machine to stay upright!



Avoid slippery surfaces.

A person slips when stepping on ice or other slippery surfaces because the person loses traction—the person's shoe does not grip the surface. The Segway HT can slip in the same way. If a Tire loses traction, then the Segway HT cannot move to stay upright and the rider could fall. To be safe, you must avoid slippery surfaces, such as snow, ice, wet floors, wet grass, or any other surface that you might slip on if you were running. Also, remember that wet, soapy, and oily Tires can lose traction and slip on any surface, so use extreme caution.

Avoid loose objects and materials.

A person can also slip by stepping on a branch, cord, or other object that rolls under foot or by stepping on loose materials like small stones. The Segway HT can slip in the same way. To be safe, you must avoid riding over loose objects or materials.



Avoid steep slopes.

A person is more likely to slip walking up or down a steep slope because he needs more traction. In the same way, if you ride your Segway HT up or down a steep slope, you are more likely to lose traction and fall. To be safe, you should avoid riding up or down steep slopes.

trips

Avoid holes, curbs, steps, and other obstacles.

If a Wheel can't move, the Segway HT is in danger of losing balance.



A person trips when she unexpectedly hits an obstacle with her foot or steps into a hole or off a curb. The person leans forward, expecting to take a normal stride, but the obstacle, hole, or curb prevents her leg from moving as expected, and she trips. The Segway HT can trip in the same way. If a Segway HT Wheel runs into an obstacle, wall, hole, or off a curb or step, the Segway HT might not be able to move as necessary to stay upright, and the Segway HT and rider could fall. To be safe, you must avoid riding into holes, walls, other obstacles, or into or off curbs or steps.

Also, you must avoid riding over any surface where the bottom of the Segway HT may strike any object.

Be careful on terrain changes.

You must be very careful when riding over any terrain change (such as from pavement to grass, or over a threshold or speed bump). Every terrain change is a potential obstacle.

Maintain Tire contact with the ground.

Both Tires must be in contact with the ground for the Segway HT to have traction. You must be very careful when riding on uneven terrain to make sure that both Tires remain in contact with the ground. If a Tire leaves the ground, that Wheel loses traction and you could fall.

tips

The Segway HT balances front to back but not side-to-side!

A “tip” is falling over sideways. People usually don’t tip because they lean to the side to maintain balance. Think of walking across a hill. You lean uphill to maintain balance. Or think about running fast around a corner. You lean into the turn. If you did not lean uphill or into the turn, you could lose balance, tip, and fall.

Lean into turns and lean uphill.

When riding a Segway HT, you must lean in the same way. The rider is responsible for maintaining side-to-side balance by leaning uphill when riding across slopes (or whenever one Wheel is higher than the other) and by leaning into turns. If the rider fails to actively maintain this side-to-side balance, the Segway HT will tip sideways and the Segway HT and rider could fall. This is why you must always lean into turns, avoid riding across steep slopes, and lean uphill when riding across any slope.

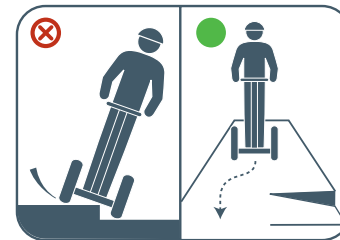
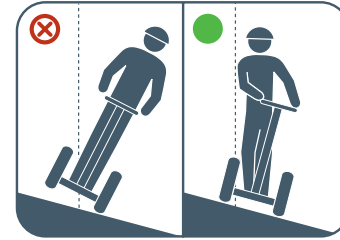
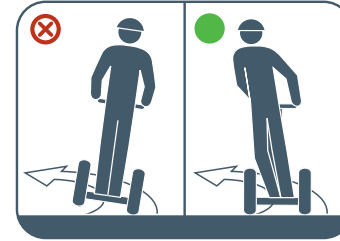

Segway HT safety features... recognize and respond

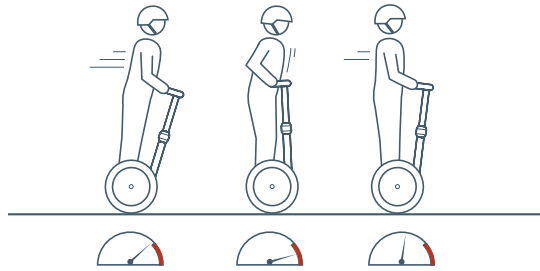

speed limiter

If the Segway HT pushes the Handlebar back, slow down!

Recognize: The Segway HT will push its Handlebar back to slow the rider down. The speed at which the Segway HT pushes the Handlebar back depends on a variety of factors, including riding style, terrain, payload, the Key used to start the Segway HT, Battery Pack condition, and other factors (see the Reference Manual). When you approach the maximum allowed speed based on these factors, the Segway HT will push the Handlebar back to slow you down. This is called Speed Limiter.

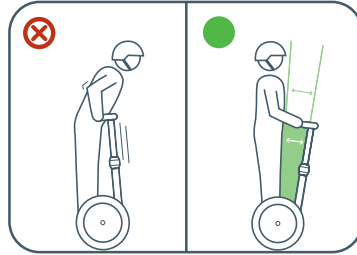

Respond: If you feel the Speed Limiter push the Handlebar back, stop leaning forward and slow down.

You should always leave a gap between yourself and the Handlebar. Riding against the Handlebar can cause loss of control, collisions, falls and injury.



stick shake warning when riding

If you feel the Segway HT shake and hear growling noises, slow down. If the shaking and growling noise persist, come to a controlled stop and safely step off.

Recognize: One of the ways that the Segway HT notifies you that you are at risk of falling is by shaking the Handlebar and making growling noises. This is called Stick Shake Warning. The Stick Shake Warning will occur if you ride backward too fast or if you demand too much power from the Segway HT, such as by riding on a steep slope, on rough terrain, against an obstacle, or by accelerating or decelerating abruptly.

Stick Shake Warning is more likely to occur when your Battery Packs are low, cold, heavily used, or poorly maintained.

See the Reference Manual for additional information about the Stick Shake Warning, and how it can occur in certain non-riding situations.

Respond: If you feel the Stick Shake Warning while riding, slow down. If the Stick Shake Warning persists, come to a stop and safely step off.

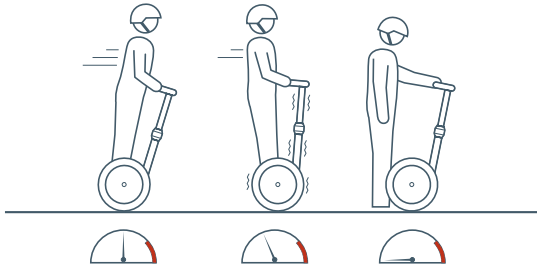

safety shutdown

If you feel the Segway HT slow down and shake its Handlebar, hear growling and beeping noises, and see the Display flash red, you should come to a stop and step off.

Recognize: If the Segway HT detects a fault in any of its redundant subsystems (see the Reference Manual for a list), the Segway HT notifies you by automatically reducing its speed, shaking its Handlebar, making growling and beeping noises, and flashing red in the Display. This is called a Safety Shutdown.

Respond: You have approximately 10 seconds from the start of Safety Shutdown to come to a controlled stop and safely step off. After approximately 10 seconds, the Segway HT will stop balancing and you must have both feet off the Segway HT.

During a Safety Shutdown, the Segway HT may stop balancing and shut down immediately if you tilt it backward too steeply, and you are stopped or moving slowly.

Any time you encounter a Safety Shutdown, you should be prepared to step off as soon as you come to a stop. Watch the Safety Video and familiarize yourself with the sound and motion of a Safety Shutdown.

Empty Battery Condition

The Segway HT will notify you of a pending empty battery condition prior to initiating Safety Shutdown.

A red unhappy face icon will appear in the Display, the Segway HT's speed will be limited, and the Segway HT will beep. In some cases, old, cold, heavily used, or poorly maintained Battery Packs may develop a high resistance condition, which could cause the Display to show the pending empty battery condition even though the Battery Packs were recently charged. Whenever you see the pending empty battery condition icon in the Display, you should come to a controlled stop and safely step off of the Segway HT prior to commencement of the Safety Shutdown.

This icon will be shown in the Display:



Never restart and ride your Segway HT after it has indicated an empty battery condition or performed Safety Shutdown due to low battery. The Segway HT may not have enough power to keep you balanced, especially if you demand a lot of power at once. If you restart and continue riding, you risk falling. Also, you risk damaging your Battery Packs, resulting in reduced Battery Pack life and capacity. Fully recharge your Battery Packs within the recommended charging temperature range prior to riding. If the condition persists, contact an Authorized Segway Dealer.

See the Reference Manual for information about the battery charge level indicator that appears in the Display.

your first ride

powering on and off and entering balance mode

When you are ready for your first ride, follow these instructions in the order listed:



Make sure you have read this entire Riders' Guide and watched the Safety Video.

1. Make sure your Segway HT is assembled and charged as described in the separate assembly instructions provided with your Segway HT.

The Segway GT comes with a Golf Bag Carrier with separate instructions and warnings for proper installation and use. **Before installing the Golf Bag Carrier, we recommend that you learn to ride as described in this guide and the Safety Video.** To reduce risk of injury, be sure to follow those separate instructions when installing and riding with the Golf Bag Carrier.

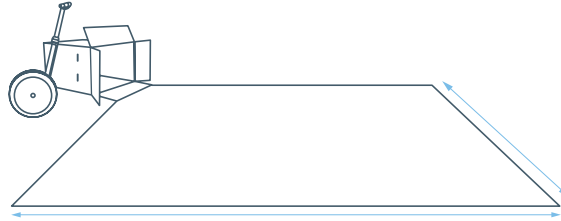

2. Select an appropriate area for your first ride. This may be an indoor or outdoor area and should measure at least 12 feet by 12 feet (4 meters by 4 meters) with no obstructions and a level, smooth riding surface with good traction, away from vehicles, bicycles, pets, small children, and other distractions.

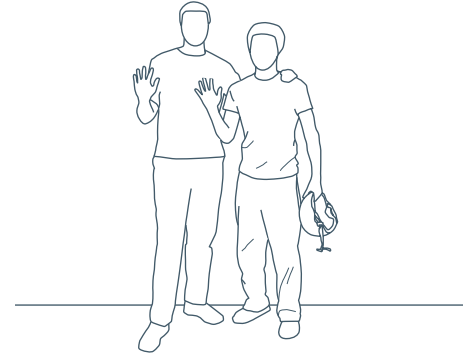

3. You will need a friend to act as your "spotter." Using a spotter is the safest way to step on your Segway HT for the first time. The spotter can also help you with these instructions so that you can concentrate on the procedure. If you try your first ride without a spotter, you are at greater risk of injury and you probably won't enjoy the experience as much.



Ask your friend to read you the instructions while you learn to ride.

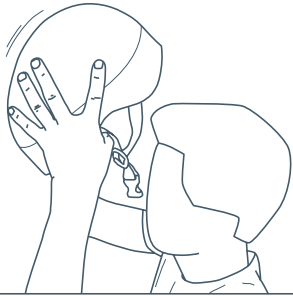

- Put on your helmet.
- If you deployed the Parking Stand (available on i Series models only), retract it before you begin.

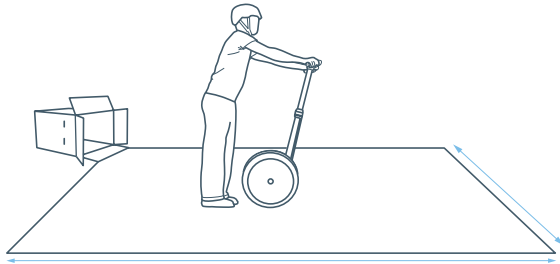

- Move the Segway HT to the center of your selected area.

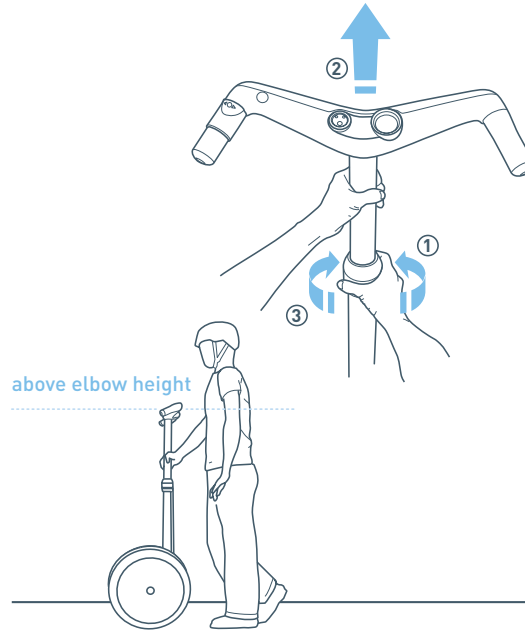



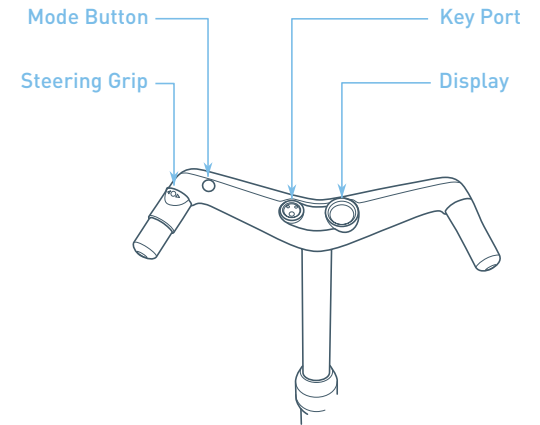

- Adjust the Handlebar height. Loosen the Height Adjustment Collar by turning it counterclockwise. Move the Handlebar until it is just above your elbow (while you are standing on the floor). Tighten the Height Adjustment Collar. Adjusting to the correct height is important for both safety and comfort.



- Acquaint yourself with the following items on the Handlebar: Steering Grip, Mode Button, Key Port, and Display.

9. Acquaint yourself with some of the icons that may appear in the Display:

display icon quick reference chart

ride	
 Full performance available (Balance Mode)	 Performance is reduced (Balance Mode)
do not ride	
 (Power Assist Mode)	 Refer to the Reference Manual

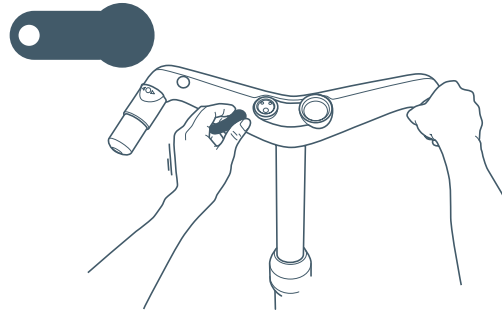

10. Gently press the Beginner Key into the Key Port. You should hear a tone as the Segway HT turns on. When you hear the tone, remove the Key. You should see this in the Display:



DO NOT STEP ON YET! YOUR SEGWAY HT IS NOW ON, BUT IT IS NOT BALANCING.

11. Remove Key.



Trouble starting up?
See the troubleshooting chapter in the Reference Manual.

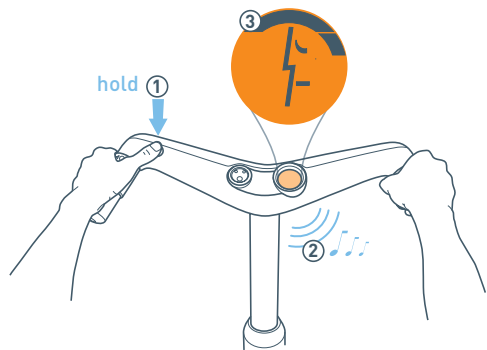

12. Before you proceed with your first ride, practice powering off your Segway HT. You turn the power off by pressing and holding the Mode Button on the Handlebar for two seconds, until the Display shows an orange sleepy face (the Display segments vary depending on software version). The Segway HT will now power off.

13. After you practice powering off, power on again with the Beginner Key so that you see the following Display:

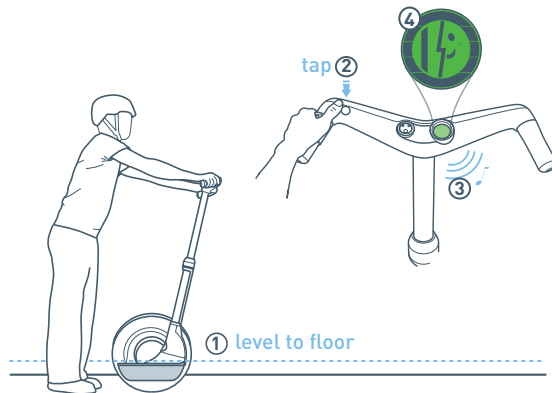
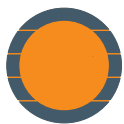

14. Stand back from, or to the side of the Segway HT. While holding the Handlebar so the Platform is level, briefly tap (press and release) the Mode Button. After you tap the Button, you should hear a tone and see a green smiling face in the Display. A green smiling face means that the Segway HT is in Balance Mode and ready to ride. You will also notice a vertical bar scrolling across the face.

Check that the Segway HT is in Balance Mode by slowly moving the Handlebar forward and back and making sure that the Wheels respond. Never attempt to step on the Segway HT unless you have confirmed that it is in Balance Mode by seeing the green smiling face in the Display, and making sure that it moves its Wheels when you move the Handlebar.

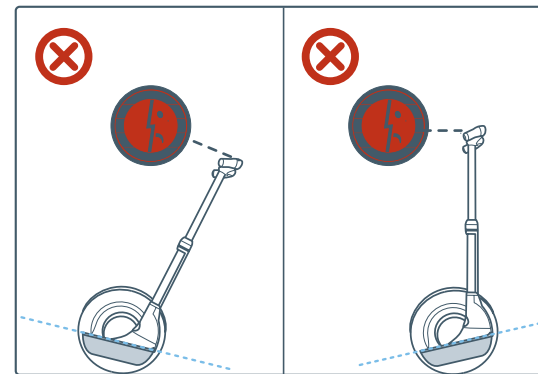

If you fail to hold the Platform level, the Segway HT will not enter Balance Mode. Move the Handlebar to make the Platform level, and then tap the Mode Button again.

**WARNING!**

Before you step on, read the following steps 1 through 15.

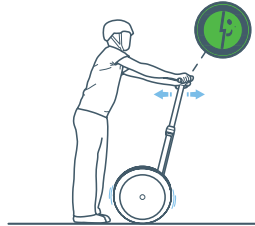

1. Make sure the Segway HT is in Balance Mode.

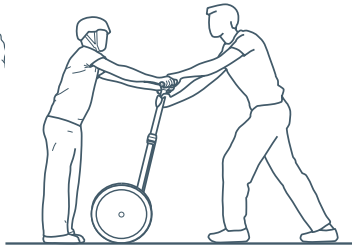
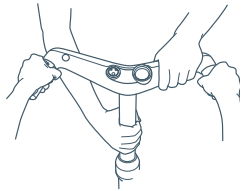

2. Have your spotter stand in front of the Segway HT, face you, and hold the Handlebar and Control Shaft securely with both hands. Your spotter should be prepared to firmly hold the Segway HT to keep it from moving.

stepping on

▼=body weight

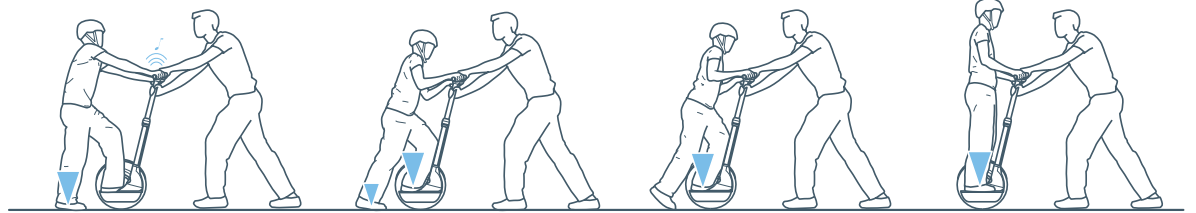

3. Now you will step on the Segway HT.
 - a) Hold the Hand Grips lightly. Be careful not to rotate the Steering Grip.
 - b) Keeping the Platform level, place just one foot on the Platform.
 - c) Slowly lift your other foot just barely off the ground. Then put it back down on the ground.
 - d) Practice slowly raising your foot off the ground and putting it back down until you can raise it without the Segway HT moving back and forth.
 - e) Try to keep your head up and look forward.
 - f) Once you can raise your foot off the ground without the Segway HT moving, SLOWLY place it on the Platform. Be prepared. Some people rock back and forth involuntarily when they first step on. Try to be calm and relaxed.
 - g) Look forward.
 - h) If you feel unstable, step off the Segway HT with both feet, one foot at a time, and pause before stepping back on.

stepping off

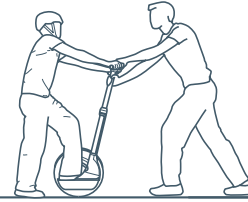
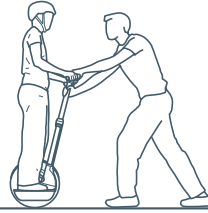
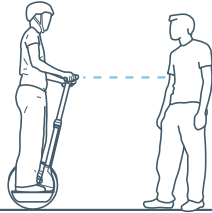

4. Once you feel comfortable, and your spotter does not feel the Segway HT pushing or pulling, have him let go and back away one arm's length. Your spotter should stand ready to grab the Handlebar, if necessary. You should try to remain still and feel the Segway HT balance. Remember, if you lean forward, the Segway HT will move forward. If you lean back, it will move back. To stay stationary keep your weight centered over the Wheels.
5. Once you are comfortable remaining still on the Segway HT, practice stepping off.
 - a) Make sure you are at a complete stop.
 - b) Have your spotter securely hold the Handlebar.

- c) Remove your left hand from the Steering Grip.
- d) Keeping the Platform level, step down to the rear of the Segway HT, one foot at a time. Continue to hold the Handlebar with the Platform level. If you tilt the Platform when the Segway HT is in Balance Mode, it will move and could bump into you or another person or object.

6. Do not let go of the Segway HT when it is in Balance Mode. After stepping off, hold onto the Handlebar until you switch to Power Assist Mode (see page 24) or power off. If you let go of the Segway HT while it is still in Balance Mode, it could run into a person or object and cause injury or damage.

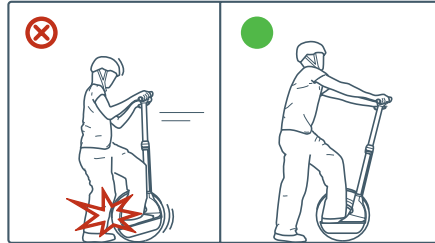

my Segway HT is vibrating!

Did you let go of the Segway HT? The vibration is a Stick Shake Warning. Don't let your Segway HT move without you.

Did you walk your Segway HT some distance? Make sure it's not in Balance Mode when you walk your Segway HT.

- Now, with your spotter helping (or just standing nearby), practice stepping on again using the same procedure. Before stepping on, check for the green smiling face in the Display and that the Segway HT moves its Wheels when you move the Handlebar.
- After you step on, slowly lean forward and feel the Segway HT move forward. Then stop leaning forward and feel it slow down and stop. Do this a few times. The further you lean, the faster it will accelerate.

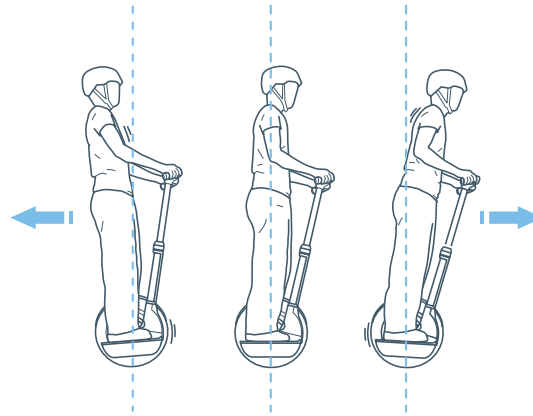

- Now slowly lean back and feel the Segway HT move backward. Then stop leaning back and feel it slow down and stop. Do this a few times. **You should not ride backward except to maneuver a few feet.** Instead, turn and ride forward. There is a difference between maneuvering backward and riding backward; similar to the difference between stepping back and walking backward. Maneuver backward only when you need to open a door or back away from an obstacle.
- Practice going forward and back. Be careful not to run the Wheels into any wall or other object. This could cause loss of control and a fall.

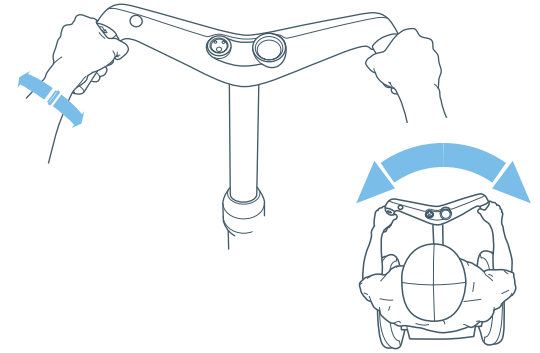

- Now practice turning in place. To turn in place, slowly and smoothly rotate the Steering Grip to the right. The Segway HT will rotate so that you turn in place. Do the same thing to the left. Practice this a few times in each direction.

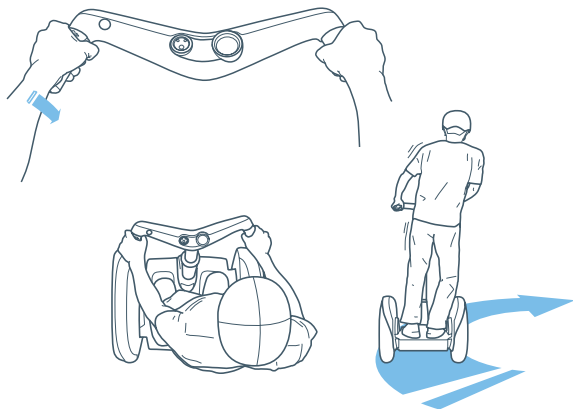

12. After you are comfortable going forward and back and turning in place, try riding forward while slowly and smoothly turning the Steering Grip. Keep your knees slightly bent and lean into the turn. Make a few circles in each direction.

13. After you make a few circles in each direction, practice stopping by shifting your weight. When moving forward, you gently shift your weight back to bring the Segway HT to a stop. Once stopped, center your weight over the Wheels to remain stationary. If you continue to lean back, you will move backward. Practice choosing a spot on the ground, and coming to a smooth controlled stop at that spot. Then remain stationary. Avoid abrupt stops and slippery surfaces. Stopping abruptly, especially on slippery surfaces, can cause the Segway HT's Tires to lose traction, and you could fall.

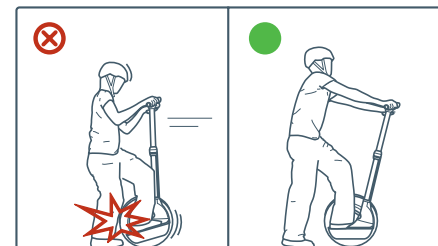

14. After you practice stopping a few times, move to the center of your riding space, stop and step off. Remember to follow the entire procedure for stepping off, described earlier.

As you step down off the Platform, do not lean backward or pull back on the Handlebar, or the Segway HT will back into you. After stepping off, continue to hold the Handlebar. Do not let go of the Handlebar until after you power off the Segway HT. You must remove both feet (one at a time) before you can power off.

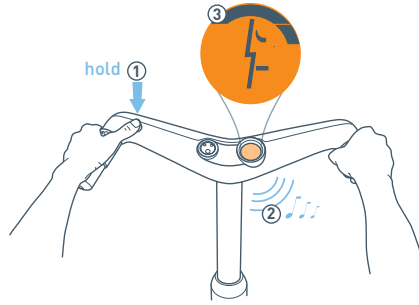

15. To power off the Segway HT, press and hold the Mode Button for two seconds, until the Display shows an orange sleepy face (the Display segments vary depending on software version). The Display will then go blank, indicating the Segway HT is powered off.

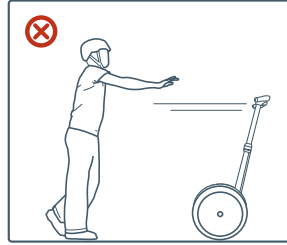

Never let go of your Segway HT when in Balance Mode, because the Segway HT will travel some distance on its own before shutting down. The Segway HT will not travel very far if you let go of it when it is stopped. But, if you let go of it when it is moving at any speed, it could travel much farther, risking injury to others and damage to the Segway HT.

Congratulations, you completed your first ride! You may feel that you are now ready for riding out in the real world, but you're not. Before you are ready for the real world, you must 1) practice so that you maneuver the Segway HT with the same precision as you walk; and 2) learn to quickly identify and avoid the situations that could cause slips, trips, and tips.

practice riding



1. Before you attempt riding in the real world, you must practice.
 - > At first, you should always use the Beginner Key and ride in areas free from obstacles and distractions.
 - > You should practice with the Beginner Key until you can step on, ride forward and backward, turn, and stop with the same precision as you walk.
 - > The more you practice riding, the safer you will be when you move out into the real world.
2. With practice you should be able to easily ride from one room to another within your home. You should be able to ride on a narrow, curving, paved walkway.
 - > Until you can ride with this precision, you should not attempt to ride in any area where you might encounter children, pedestrians, pets, vehicles, bicycles, or other obstacles and potential hazards, and you should use only the Beginner Key. Once you are able to ride using the Beginner Key with the same precision as you walk, you can try the other Keys.
3. Your first rides with the other Keys should be in the same secure areas where you learned to ride with the Beginner Key.
 - > **Be prepared for, and carefully acquaint yourself with the more sensitive turning rates of the other Keys. When you first use one of the other Keys, be especially careful to turn the Steering Grip very slowly.**
 - > After you have practiced with the other Keys (see “use the appropriate key” on page 26) in the secure areas until you can ride with the same precision as you walk, you can gradually move to more challenging riding environments.
 - > You should not ride in any location where you might encounter children, pedestrians, pets, vehicles, bicycles, or other obstacles and potential hazards until after you have practiced riding on similar terrain with no such potential hazards.

riding form

Your posture and stance have a big effect on your ability to ride safely:

- > Be alert and look ahead—your eyes are your best tool for safely avoiding obstacles and slippery surfaces.
- > Keep your legs and arms loose, knees and elbows bent. This helps you absorb vibration and keeps the Segway HT stable and under control.
- > Use a light grip on the Handlebar, don't hold too tightly. Expect some side-to-side motion on bumpy terrain.
- > Leave a gap between yourself and the Handlebar. Do not lean over or into the Handlebar. Leaning over or into the Handlebar dramatically increases the risk of loss of control, collisions, and falls.
- > Make sure the Handlebar is set to the correct height.
- > Keep your feet centered on the mat.

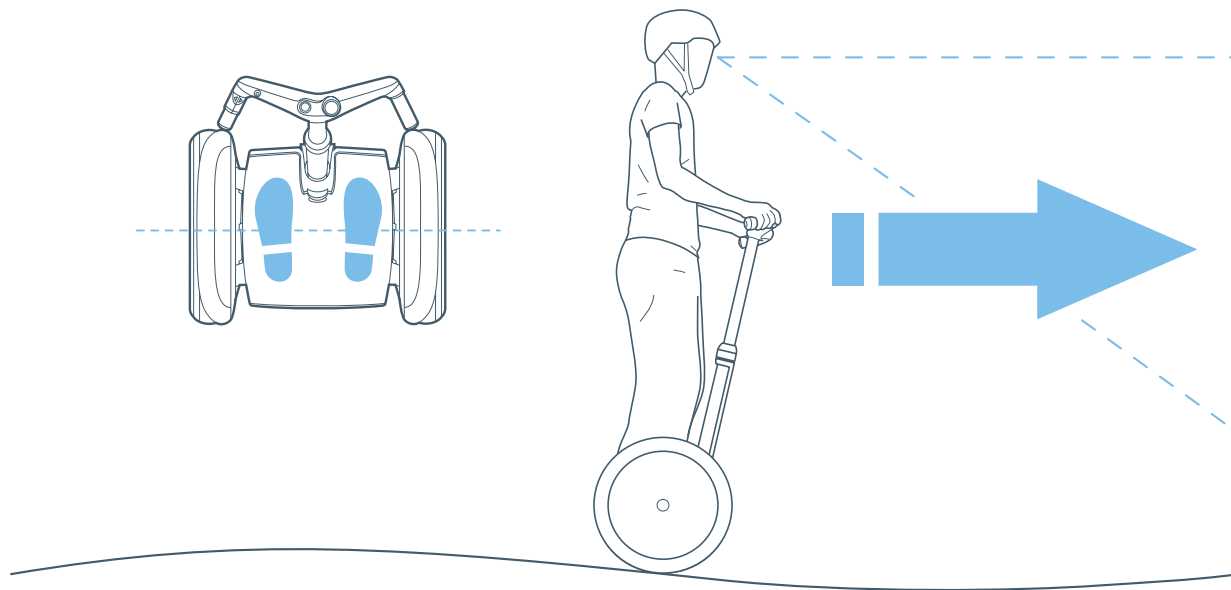

riding techniques

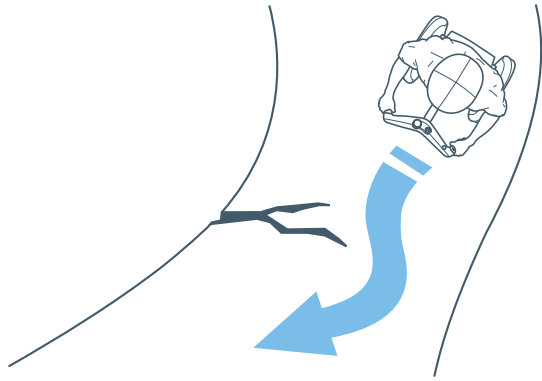

avoid slips, trips, and tips

Now that you know how to ride, reread the sections of this guide on slips, trips, and tips (pages 7 and 8). You must learn to identify and avoid slippery surfaces, loose materials, steep slopes, and obstacles.



turning

Because fast turns can be dangerous, turn the Steering Grip slowly. Always lean into the turn. Hold the Steering Grip loosely and be careful not to unintentionally turn it. Practice your technique!



terrain features

With practice you can learn to ride over many different types of terrain, provided you avoid slippery surfaces, loose materials, steep slopes, and obstacles. Always proceed slowly over unfamiliar terrain. Lean uphill whenever one Wheel is higher than the other. Never allow the Segway HT to become airborne, even for short periods of time, because the Segway HT has no traction when airborne and you could lose control upon landing.

power assist mode

When you first power on your Segway HT, it will automatically be in Power Assist Mode, a non-balancing mode. You must not attempt to ride the Segway HT when in Power Assist Mode. Use this mode while walking with the Segway HT to move over slippery surfaces; over obstacles; up and down steps; up, down, or across steep slopes; and elsewhere where riding is not safe and appropriate.

When your Segway HT is in Power Assist Mode, this will appear in the Display:

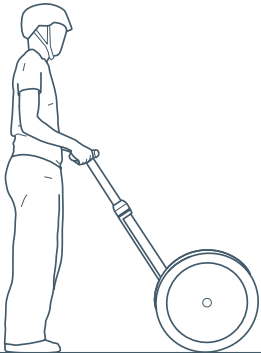
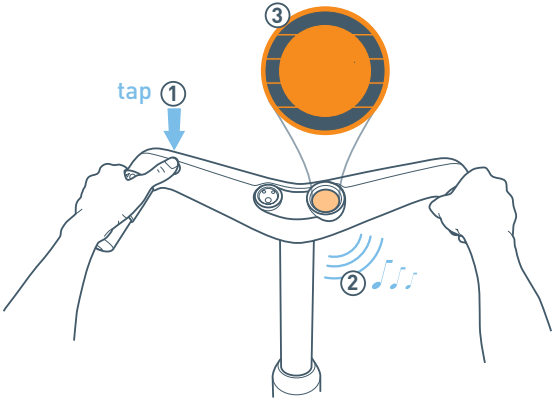

Power Assist Mode

To switch from Balance Mode to Power Assist Mode, step off and tap the Mode Button. Then check the Display to make sure the Segway HT is in Power Assist Mode.

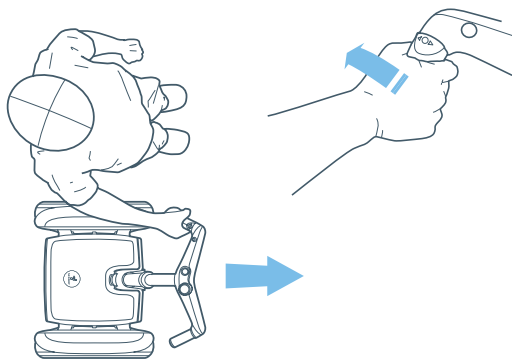

When the Segway HT is in Power Assist Mode, the Steering Grip can be used to power the Wheels. You should stand to the side so that you do not run the Segway HT into your shins.

Twisting the Steering Grip produces forward or backward motion. **The Segway HT responds quickly to your command, so be prepared and rotate the Grip slowly.** Until you become familiar with how the Segway HT moves in Power Assist Mode, you should stand to the side of the Segway HT so that you do not run the Segway HT into your shins.

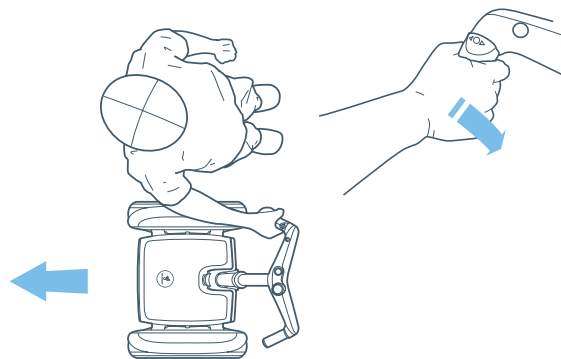

Practice moving the Segway HT back and forth to get the feel of Power Assist Mode.

Once you are familiar with the Segway HT's movement when in Power Assist Mode, you can move around to the front of the Segway HT and hold both Hand Grips for more control.

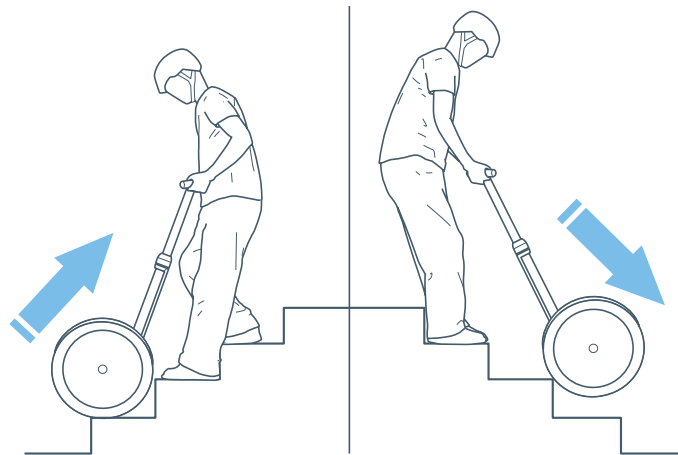

When using Power Assist Mode (and even when the Segway HT is powered off), keep the Segway HT below you at all times. Lead it up steps and slopes. Keep it below you when descending steps and slopes.

use the appropriate key

The Segway HT comes with different Keys, depending on your Segway HT model:

- > **i Series, p Series, Segway GT:** one Beginner Key, one Intermediate Key, one Advanced Key.
- > **Segway XT:** one Beginner Key, one Advanced Key.

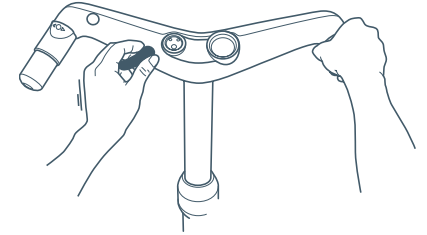

The Intermediate and Advanced Keys are provided separately because you should only use those Keys after you have learned to ride using the Beginner Key. Riding with the Intermediate and Advanced Keys require more skill than riding with the Beginner Key.

The maximum forward speed and turning rate are set at different levels, depending upon the Key used to power on. With each Key, you may ride at any speed up to the maximum forward speed allowed by that Key.

When you use the Intermediate and Advanced Keys, you must become familiar with the increased turning responsiveness.

Remember to turn the Steering Grip carefully and always lean into turns. It will take some practice for you to get used to this increased responsiveness. Have fun practicing!

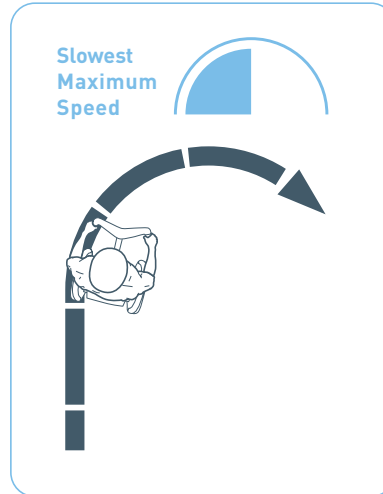

The Beginner Key is appropriate for all new riders.

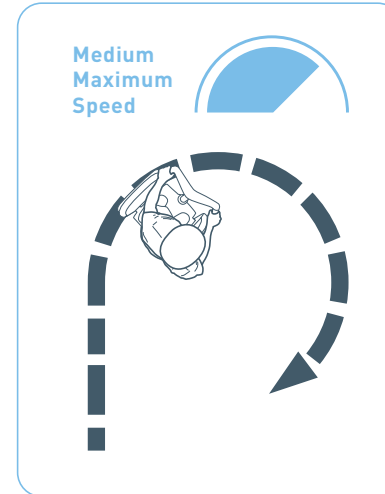

The Intermediate and Advanced Keys are suitable for more experienced riders.

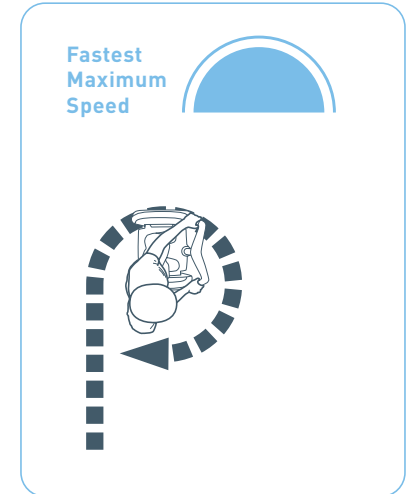



rules to ride by

The Segway HT's unique balancing ability and ease of use can lead you to become overconfident. If you exceed the ability of the Segway HT to balance, such as by riding over obstacles, uneven terrain, slippery surfaces, loose materials, or steep slopes, you can very quickly lose control, leading to collisions, falls, and injury. As with any other transportation device, using a Segway HT exposes you to risk of injury. You can reduce the risk by following all the instructions and warnings in this guide, but you cannot eliminate the risk. Whenever you ride, follow these rules:

- > **Read this guide and watch the Safety Video.**
Do not allow any person to use your Segway HT unless that person has carefully read this guide and watched the Safety Video.
- > **Wear a helmet.**
Whenever you ride your Segway HT wear a helmet that fits properly with the chin strap in place. Use an approved bicycle or skateboard helmet that provides protection for the back of your head. Depending upon riding conditions and your riding experience, consider using additional protective equipment, such as gloves, eye protection, wrist guards and knee pads. Wear footwear that protects your feet and provides adequate support and comfort.
- > **Spot new riders carefully.**
All new riders should use the Beginner Key.
The safety of new riders is your responsibility. Do not allow anyone to step onto the Segway HT for the first time unless you are there to hold the Handlebar. Spot new riders until they are comfortable with the basic operation of the Segway HT. Don't let new riders operate the Segway HT outside of your direct supervision unless they have read this guide and watched the Safety Video.
- > **Avoid slippery surfaces, loose materials, steep slopes, and obstacles.**
If you cannot avoid a slippery surface, loose material, steep slope, or obstacle, then you must step off and use Power Assist Mode to move across it. Be especially careful when riding in confined spaces or near obstructions.
- > **Use caution on slopes.**
Use caution when ascending, descending, or crossing slopes. Do not attempt to ride up, down, or across steep slopes or slopes with loose material or slippery surfaces. Instead, step off and use Power Assist Mode, walking with the Segway HT held downhill from you. When riding up, down, or across any slope, lean uphill to maintain balance.



- > **You're taller than you think.**
Be aware of the added height that the Segway HT (and your helmet) gives you and use caution when riding indoors or in the vicinity of doorways, archways, branches, signs, or other low overhead obstacles.
- > **Watch those turns!**
Always turn slowly and with caution. Fast turns can lead to loss of control and falls. Lean into turns.
- > **Don't risk it.**
When you encounter a slope, uneven terrain, or other terrain feature with which you are not experienced or that makes you at all concerned about your safety, do not risk riding over it. Instead, step off and use Power Assist Mode



- > **No passengers.**
The Segway HT is for one rider. Do not ride double or carry any passengers. Do not carry a child in your arms or in a child carrier while riding.
- > **No stunts.**
Do not attempt to perform any type of tricks, stunts, or racing on your Segway HT.
- > **Not a medical device.**
The Segway HT has not been designed, tested or approved as a medical device. You must be able to step on and off the Segway HT unassisted, which requires physical abilities similar to ascending and descending stairs without assistance, and without holding the handrail. You must be able to operate the steering control with your left hand.

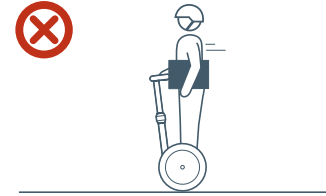

- > **Both hands, both feet.**
When riding, keep both hands on the Grips and both feet on the Platform (not extending beyond the Platform in front or back). Do not attempt to carry any object in your hand(s). If you need to carry any object, use a Segway-approved cargo accessory or a securely attached backpack with both shoulder straps in place.
- > **Never ride on stairs or through revolving doors.**
Riding on stairs is extremely dangerous, as is riding on escalators and through revolving doors.
- > **Don't step off a moving Segway HT**
Always come to a stop before stepping off.

> **Don't ride in the dark.**

Do not ride the Segway HT in low visibility conditions without a light. To ride safely, you must be able to clearly see what is in front of you and you must be clearly visible to others.

> **Be relaxed.**

Ride in a relaxed position with your knees and elbows slightly bent and head up.

> **Be prepared to stop.**

Be especially careful when approaching or crossing intersecting streets, driveways, corners, doorways, and other areas where you may need to slow down or stop to avoid motor vehicles, bicyclists, or pedestrians.

> **Be alert.**

As with any other transportation device, you must be mentally alert to safely ride a Segway HT. Do not attempt to ride if you are ill or if you cannot comply fully with the instructions and warnings in this guide. Do not ride under the influence of alcohol or drugs.

> **Avoid distractions.**

Do not use a cell phone, listen to headphones, or engage in any other activity that might distract you or interfere with your ability to monitor your surroundings while riding.

> **Don't ride backward.**

You should not ride backward, except to maneuver a few feet. Instead, turn and ride forward. There is a difference between maneuvering backward and riding backward, similar to the difference between stepping back and walking backward. Maneuver backward only when necessary to open a door or back away from an obstacle.

> **Never restart and ride your Segway HT after it has indicated an empty battery condition or performed a low battery Safety Shutdown.**

The Segway HT may not have enough power to keep you balanced, especially if you demand a lot of power at once. If you restart and continue riding, you risk falling. Also, you may damage your Battery Packs resulting in reduced Battery Pack life and capacity.

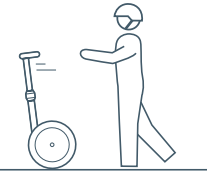

> **Never let go of a balancing Segway HT.**

Never let go of your Segway HT when in Balance Mode, because the Segway HT will travel some distance on its own before shutting down. The Segway HT will not travel very far if you let go of it when it is stopped. But, if you let go of it when it is moving at any speed, it could travel much farther, risking injury to others and damage to the Segway HT.

> **Riding on the road.**

The Segway HT is not intended or recommended for primary use on streets or roads. If you must ride on the road, or must cross the road, be extremely careful. Ride as far away from traffic as possible. Allow plenty of time for crossing roads. Remember, the Speed Limiter or an unexpected obstacle could slow your crossing. Check to make sure that riding on the road is allowed by law.

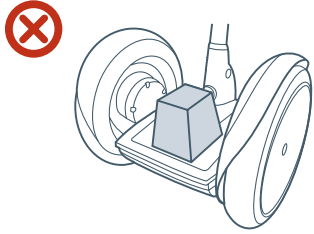

> **Carrying cargo.**

To carry cargo, use a Segway-approved cargo accessory or a securely attached backpack with both shoulder straps in place. Do not place cargo (or any object) on the Platform. The total weight of any Handlebar payload plus any other attachments hanging from the Handlebar should not exceed 10 lbs. (4.5 kg). Exceeding this limit interferes with the Segway HT's balancing ability and could cause the Segway HT to accelerate on its own, risking injury and damage.

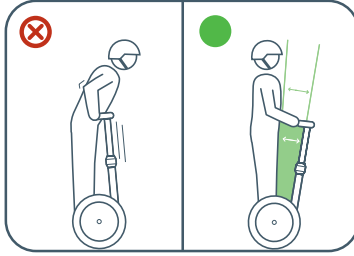

> **Leave a gap!**

Leave a gap between yourself and the Handlebar. Do not lean over or into the Handlebar. Leaning over or into the Handlebar dramatically increases the risk of loss of control, collisions, and falls.

please read and follow

> **Weight limits.**

Don't exceed the maximum weight limit (rider and all cargo) specified in the Reference Manual. If you exceed the maximum weight limit, you are at greater risk of falling and injury, and damage to the Segway HT could result. Also, the rider's weight must not be less than the minimum rider weight limit specified in the Reference Manual. If you are below the minimum rider weight limit, you may not be able to ride safely because you cannot shift your weight far enough back (behind the center line of the Wheels) to safely slow down and stop, especially when riding downhill. Riders below the minimum weight limit might also fail to properly activate the Segway HT's balancing system.

> **Young riders.**

Because safe riding of the Segway HT requires adherence to all the instructions in this guide, Segway recommends that you not allow children to ride your Segway HT unless: (a) you have first learned to ride, so that you understand the care and skill required to ride safely; (b) the child has read this entire guide and watched the entire Safety Video; and (c) you are satisfied that the child has the knowledge, maturity, and physical ability to ride safely without endangering herself or others. As a general rule, Segway recommends that riders be at least 16 years of age.

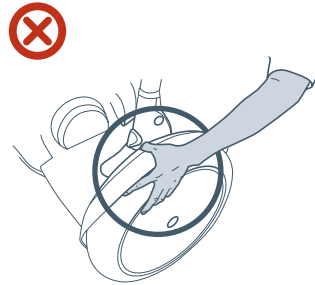

> **Ouch.**

Keep your fingers away from turning Wheels and Fenders. Keep Wheel Inserts installed. Some Wheels contain interchangeable Wheel Inserts. To reduce risk of injury from the Wheel openings, make sure the Wheel Inserts are properly installed.

> **Maintain Tire air pressure.**

Maintain Tire air pressure at the level stated on the label attached to the Wheel, not the pressure that may be stated on the Tire sidewall. If you exceed the Tire air pressure stated on the Wheel label, you increase the risk of loss of control, collisions, and falls. Lower pressure reduces range and risks Tire and Wheel damage.

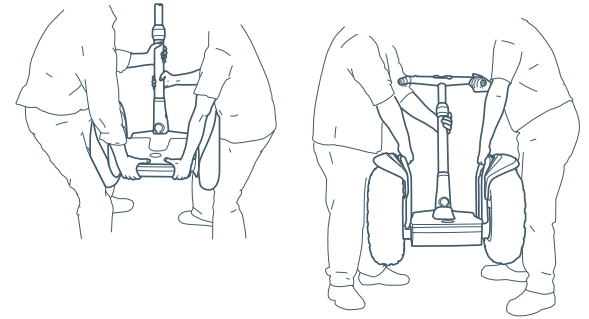

> **Loading and lifting techniques.**

Make sure the Segway HT is powered off prior to lifting. Use safe and appropriate loading and lifting techniques. Segway recommends that two people work together to lift the Segway HT. Each person should place one hand on the Control Shaft (below the Height Adjustment Collar). Each person should place the other hand under the Platform or, with the Segway XT, use the lifting handles on the Fender Frames. Lift with your legs, not your back. Never lift the Segway HT by its Tires, Fenders, or Wheels because your hands or fingers could become caught between the Tire and the Fender, resulting in injury.

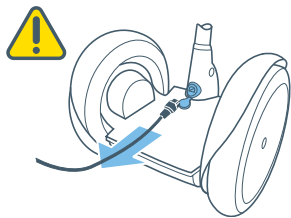

- > **Unplug before servicing.**
Disconnect your Segway HT from AC power before removing or installing Battery Packs or performing any other service. See the Reference Manual for additional warnings and instructions regarding service.
- > **Pre-ride inspection.**
Inspect your Segway HT before each use. Do not use if any part is loose or damaged. If you discover any loose or damaged part, consult the Reference Manual.
- > **Clear the Platform.**
Do not place any objects on the Platform. This could cause the Segway HT to move on its own when in Balance Mode.
- > **Do not separate the Tire from the Wheel.**
You could damage your Segway HT and render it unsafe to use.

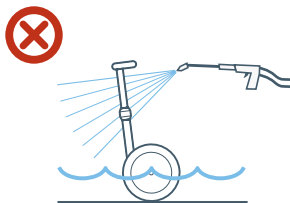

- > **Avoid submersion.**
Do not submerge the Battery Packs or Platform in water. Do not wash the Segway HT with a power washer or high pressure hose. Avoid getting water in the Charge Port. Always close the Charge Port Cover after charging.
Avoid exposure to heavy downpours or extended periods of heavy rain (including during riding, storage, or while being transported.) If your Segway HT has been exposed to a heavy downpour or an extended period of rain, refer to the Reference Manual for instructions.
Clean with soap and water and a soft cloth.
- > **Dry Charge Port and Key Port.**
Make sure that the Charge Port is dry before you plug in the Power Cord. If the Key Port becomes wet, the Port may not recognize the Key. Dry it before attempting to power on.

- > **Do not open the Platform.**
There are no user serviceable parts inside the Platform. By opening the Platform, you risk electric shock injury. Also, you could void your limited warranty, damage your Segway HT, and render it unsafe to use.
- > **Do not open the Gearboxes.**
There are no user serviceable parts inside the Gearboxes. You could damage your Segway HT and render it unsafe to use.
- > **Do not use in hazardous atmospheres.**
The Segway HT has not been certified for use in hazardous atmospheres as defined in NFPA 70, National Electric Code. Hazardous atmospheres are locations where fire or explosion hazards may exist due to flammable gases, vapors, liquids, dust, or fibers.
- > **Do not remove any component.**
Follow the instructions in the Reference Manual for servicing your Segway HT.

Segway HT etiquette... a chance to make a difference

Your behavior, attitude, and perspective will set the course for the future of personal transportation.

- > Be careful and considerate of others.
- > Always ride under control at a speed that is safe for you and those around you.
- > Always be prepared to stop.
- > Respect pedestrians by always yielding the right of way.
- > Avoid startling pedestrians. When approaching from behind, announce yourself and slow down to walking speed when passing. Pass on the left whenever possible. When approaching a pedestrian from the front, stay to the right and slow down to save the pedestrian from unnecessary concern. The Segway XT is designed for off-pavement applications, and is not intended for use on sidewalks.
- > In heavy pedestrian traffic, slow down and proceed at the pace of pedestrian traffic.
- > Pass only if there is ample space to do so safely. Do not weave in and out of pedestrian traffic.
- > When riding with other Segway HT riders, maintain a safe distance, identify hazards and obstacles, and do not ride side-by-side unless there is plenty of room left for pedestrians.
- > Do not park your Segway HT in a way that blocks pedestrian traffic.
- > Do not use your Segway HT as a toy with which to perform tricks or stunts.
- > Cross roads at designated crosswalks or signaled intersections. Do not jaywalk/ride.
- > Only travel on a road when a pedestrian way is not available or when sidewalk use is not allowed.
- > Do not ride your Segway HT on private property (inside or outside) unless you have obtained all necessary permission to do so.
- > Learn about and obey applicable laws and regulations.

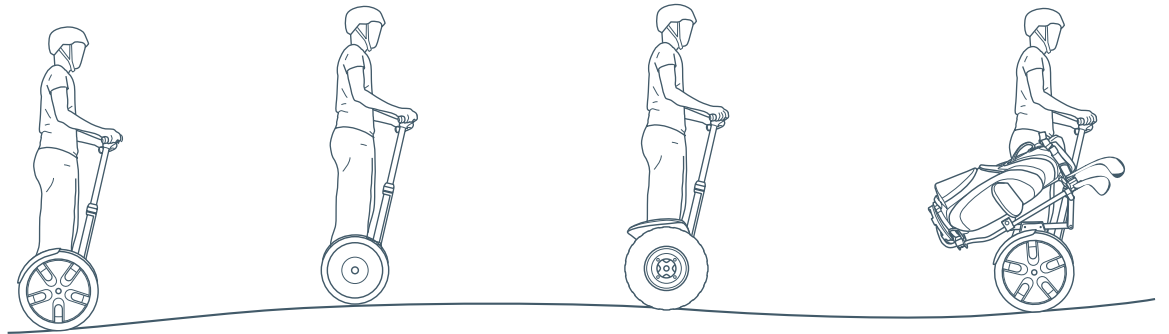

notes

report all incidents

If you or any other user of your Segway HT is involved in an accident, or if your Segway HT performs in a way that you do not intend or in a way that it is not supposed to, contact Segway Customer Operations.

Phone: 1-866-4SEGWAY (1-866-473-4929)

Fax: 1-603-222-6001

Email: technicalsupport@segway.com

Website: www.segway.com

obey all laws and regulations

Many states and municipalities regulate use of Segway HTs on public roads, sidewalks and paths. In addition to other requirements, these laws and regulations may prescribe minimum ages for Segway HT riders and may set speed limits and mandate protective gear for riders. Some governmental authorities prohibit use of Segway HTs on public roads, sidewalks and paths. You should consult local authorities to become familiar with applicable laws and regulations. (In the USA, many of these laws use the term “Electric Personal Assistive Mobility Device” or “Personal Motorized Mobility Device,” which are specifically defined to include Segway HTs.)

consult the reference manual and website

Segway also provides a detailed Reference Manual for your Segway HT, with important information about Display messages, reading the battery charge level, battery charging, maintenance, troubleshooting, and other matters. Check the website for updates to Segway HT user materials: www.segway.com.

be safe... and enjoy the ride.

fun, smart transportation



www.segway.com